

L-Series
Start-Stop Interface

Temposonics-LH
Measuring length 50 - 3000 mm



Superior Precision

**High Pressure Stainless Steel Sensor
with 100°C Electronics**

Linear, Absolute Measurement

Contactless Sensing with Highest Durability

Rugged Industrial Sensor, EMC shielded and CE certified

Linearity Tolerance better 0,02 %

Repeatability 0,001 %

Start/Stop Pulse Transmission

Operating Temperature up to 100° C



...the measurable difference

Magnetostriction

The *absolute Temposonics*® linear position sensors are based on the MTS developed *magnetostrictive* measurement principle. That combines various magneto-mechanical effects and uses the physical high precise speed-measurement of an ultrasonic wave (torsion pulse in its sensor element) for position detecting. Sensor integrated signal processing transforms the measurements directly into market standard outputs. The *contactless* principle - an external movable magnet marks the position - eliminates the wear, noise and erroneous signal problems and guarantees the best durability without any recalibration.

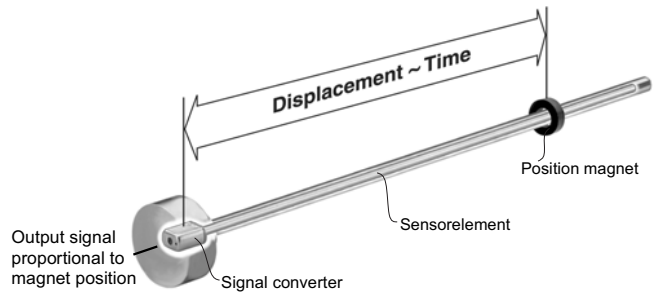

Operating principle:
Magnetostrictive ultrasonic speed measurement = Position sensing

Technical Data

Input

Measured variable Displacement
Measuring range 50 - 3000 mm

Output

Start-Stop pulse RS 422 differential signal

Accuracy

- Resolution 0,1 mm / 0,01 mm / 0,005 mm (controller dependent)
- Linearity < ± 0,02 % F.S. (Minimum ± 50 µm)
- Repeatability < ± 0,001 % F.S.
- Update frequency Controller dependent

Operating conditions

Magnet speed Any
Operating pressure 350 bar (530 bar peak pressure)
Operating temperature -40 °C ... +100 °C
Dew point, humidity 90% rel. humidity, no condensation
Sealing IP67 if mating connector is correctly fitted
Shock test 100 g single hit, IEC-Standard 68-2-27
Vibration test 10 g / 10 - 2000 Hz, IEC-Standard 68-2-6
Norms, EMC test Electromagnetic emission EN 50081-1
 Electromagnetic immunity EN 50082-2
 EN 61000, Criteria A, CE-qualified

Form factor, material

Sensor head Aluminum
Rod with flange Stainless steel 1.4301 / AISI 304
Position transmitter Ring- or U-Magnet

Installation

Mounting position Any
Rod Threaded flange M18 x 1,5 or 3/4" -16 UNF-3A, hex nut M18
Magnet Mounting plate and screws: amagnetic

Electrical connection

Connection type 6 pin connector M16 or 2 m cable outlet
Input voltage 24 VDC (-15 / +20 %)
Current consumption 100 mA typical
Ripple < 1 % peak-peak
Electric strength 500 V (DC ground to machine ground)

Formfactor

The extremely robust sensor, ideal for continuous operation under harshest industrial conditions is completely modular in mechanics and electronics design.

- A rod-shaped sensor housing protects the sensing element in which gives rise to the measurement signal.
- The sensor head accommodates the complete modular electronics interface with active signal conditioning. Double encapsulation ensures high operating safety and optimum EMC protection.
- The position transmitter, a permanent magnet - fixed at the mobile machine part - drives contactlessly over the sensor's stroke and starts measuring through the housing wall.

Temposonics-LH ... high pressure rod design

Measuring length 50 - 3000 mm

Temposonics-LH with pressure-resistant stainless steel flange and sensing rod is suitable for use in hydraulic cylinders and externally in all applications where space is a problem. Position measurement is via ring or U-magnets travelling along the sensing rod without any mechanical contact.

Advantage...

the completely operable sensor cartridge can be replaced for servicing easily without opening the fluid circuit.

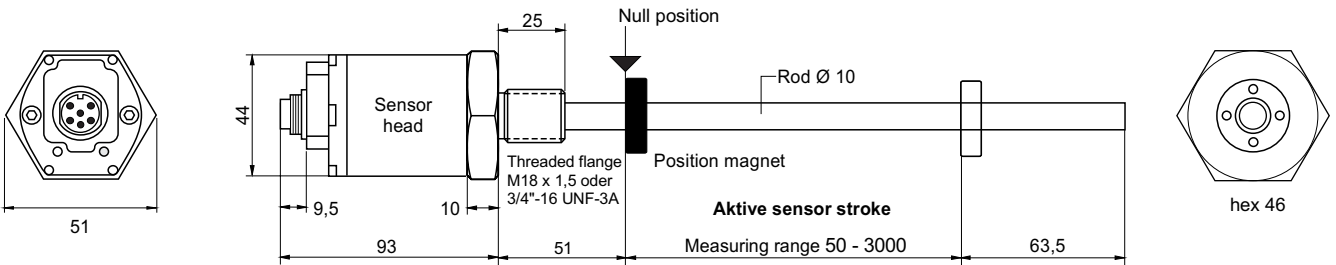

All dimensions in mm

Connection types

Connector outlet D600
6 pin male connector M16

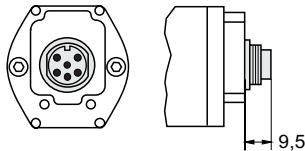

Cable outlet R002

Max. operating temperature: 70° C
6 wires PVC cable, 3 x 2 x 0,14 mm² shield, cable-Ø 6 mm, bending radius 50 mm at fixed installation

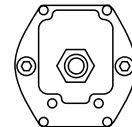

Cable outlet T002

Max. operating temperature: 150° C
8 wires Teflon cable, 4 x 2 x 0,25 mm² shield, cable-Ø 7,5 mm, bending radius 75 mm at fixed installation

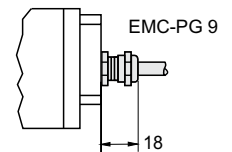

Available position magnets (pls. order separately)

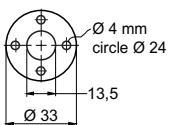

Ring magnet OD33 (standard)
Part No. 201 542-2
Height: 8 mm
Composite PA-ferrite-GF20
weight ca. 14 g, operating temperature -40...+100° C

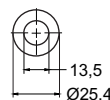

Ring magnet OD25,4
Part No. 402 316
Height: 8 mm
Composite PA-Ferrite,
weight ca. 10 g, operating temperatur -40...+100° C

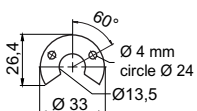

U-magnet OD33
Part No. 251 416-2
Height: 8 mm
Composite PA-ferrite-GF20
weight ca. 11 g, operating temperature -40...+100° C

Start/Stop output

Digital Temposonics-LH is equipped with a start/stop output. The sensor requires a start signal from an external indicator in the control system and returns a signal corresponding to the magnet position. The time elapsed between the two signals is proportional to the magnet position, i.e. to the displacement. Time measurement is by the controller and used for calculating the position value.

Logic diagram

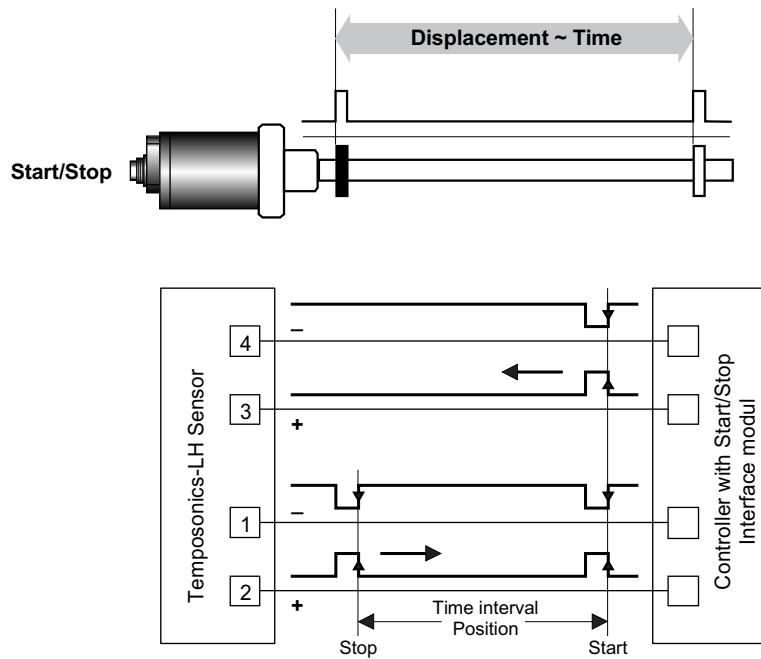

Linearity protocol

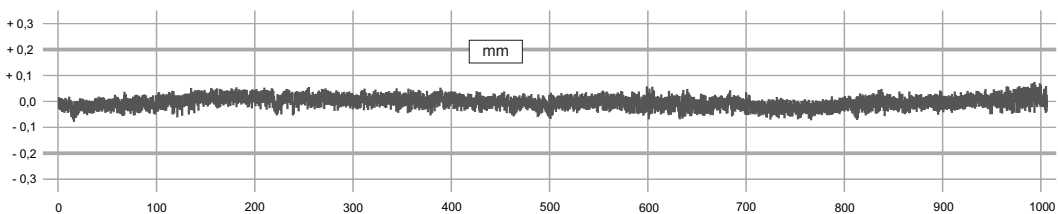

Sensor Temposonics-LH, stroke length 1000 mm
 Tolerance allowed: $\pm 0,2$ mm
 Tolerance measured: $\pm 0,09$ mm uncorrected

Variable mounting in any position

Rod

Mount the sensor directly via flange or by means of the nut packed with the sensor. If possible, non-magnetizable material should be used for the sensor mounting component. Taking the mounting dimensions shown right into account is indispensable.

Position magnet

To have a neat magnetic field for measurement, antimagnetic material must be used for the position magnet mounting component (screws, spacers, etc.).

Horizontal installation

With horizontal mounting, sensors with a measuring length from 1 meter must be provided with mechanical support at the rod end, and with supports distributed regularly over the length if the measuring rod is very long. In this case, open ring magnets must be used as position transmitter.

Hydraulic sealing

Recommended is sealing of the flange facing with an O-Ring (e.g. 22,4 x 2,65) in a cylinder cover nut.

Sample: Sensor support

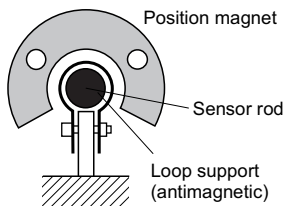

Minimum assembly distance

1. Non-magnetizable material

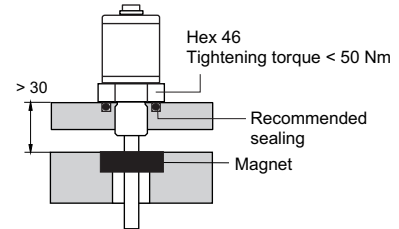

2. Magnetizable material

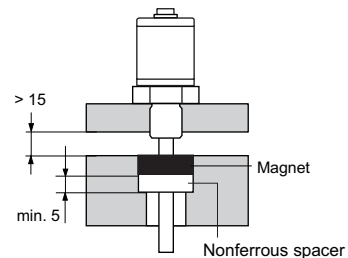

Cylinder installation

Due to form factor, a rod sensor is excellently suited for direct stroke measurement in fluid cylinders. The magnet, mounted on the piston bottom, drives contactlessly along the stroke and marks exactly the position through the rod wall - independent of the used hydraulic fluid - that guarantees a longlife and trouble-free operation.

The sensor cartridge can be removed from the flange and rod housing while still installed in the cylinder. This procedure allows quick and easy sensor cartridge replacement, without the loss of hydraulic pressure.

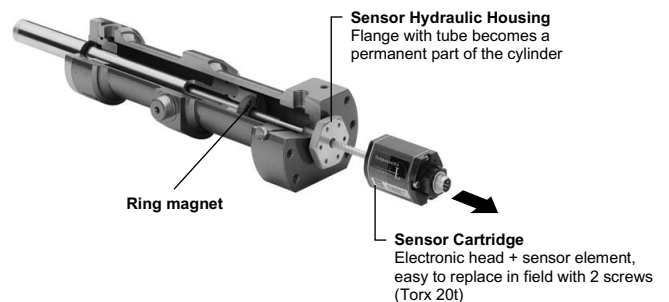

Notes

- Magnet must not slide along the sensor tube
- Bore in the piston rod and type of sealing depends on pressure and piston velocity (13 mm min.)
- Do not exceed peak pressure
- Protect sensor rod from wear

Wiring

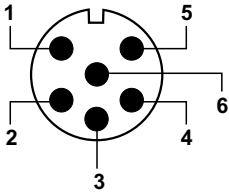

Pin	Cable color	Function
1	gray	Stop (-)
2	pink	Stop (+)
3	yellow	Start (+)
4	green	Start (-)
5	brown	+ 24 Vdc ($\pm 10\%$)
6	white	DC Ground (0 V)

View:
Front face of sensor plug
rear of mating connector

Mating connectors (recommended, not on delivery)

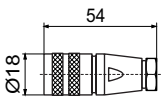

6 pin female connector M16, PG 7
Part No. STC0 9131 D

6 pin female connector M16, PG 9
Part No. STC0 9131 D06 PG9

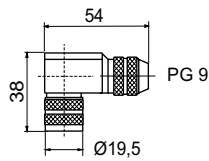

6 pin 90° female connector M16
Insert adjustable in 45° positions
Part No. STC0 9131-6

Housing: Zinc, nickel plated
Termination: Solder
Contact insert: Silver plated
Cable clamp: PG 7 / 9

Temposonics-LH Start/Stop....



... Pioneers, Innovators, Leaders in Magnetostrictive Position Sensing

**Der Sensor-Shop in Lüdenscheid: www.temposonics-shop.de
Service Hotline: 01805-mtssensor**

© MTS/Temposonics-LH start/stop OEM.101005e • Alterations reserved



Germany

MTS Sensor Technologie
GmbH & Co.KG
Auf dem Schüffel 9
D-58513 Lüdenscheid
Tel. +49-2351-9587-0
Fax +49-2351-56491
info@mtssensor.de
www.mtssensor.de

USA

MTS Systems Corporation
Sensors Division
3001 Sheldon Drive
Cary, N.C. 27513
Tel. +1-919-677-0100
Fax +1-919-677-0200
info@mtssensors.com
www.mtssensors.com

Japan

MTS Sensors Technology Corp.
Ushikubo Bldg.
737 Aihara-cho, Machida-shi
Tokyo 194-0211
Tel. +81-42-775-3838
Fax +81-42-775-5512
info@mtssensor.co.jp
www.mtssensor.co.jp